

NOTE: SEE AMYA ONL #72 FOR INFORMATION PERTAINING TO THIS BULB SHAPE

# ADVANCE MK I

A CARL G. SCHAEFER, JR. DESIGN

THIS DESIGN CONFORMS TO THE AMYA CLASS ONE METER SPECIFICATIONS

ONE METER CLASS

SUGGESTED SAIL PLAN

MAIN	324	SQ IN
JIB	<u>273.2</u>	SQ IN
TOTAL	597.2	SQ IN

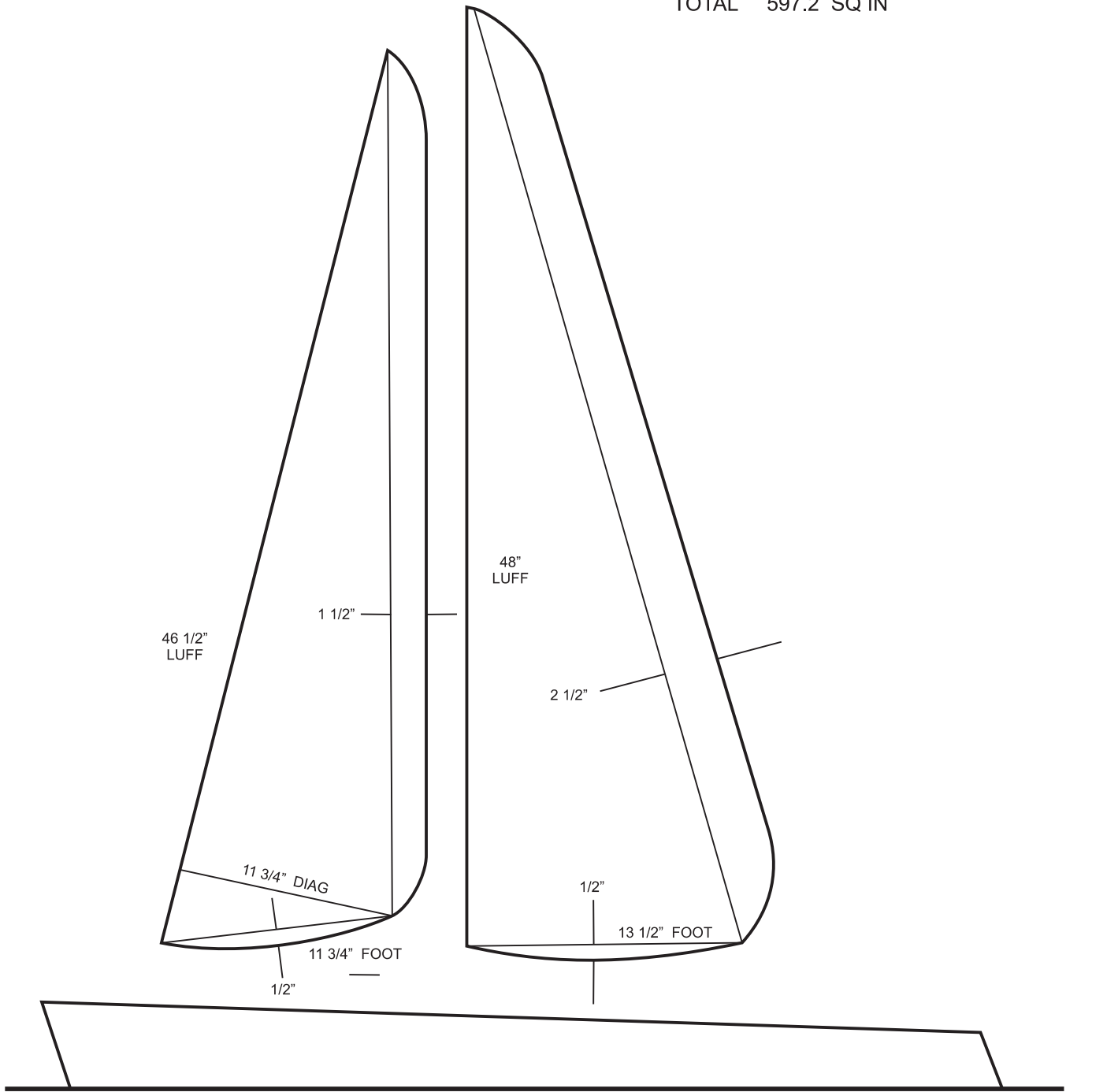

ADVANCE MK I

A CARL G. SCHAEFER, JR. DESIGN

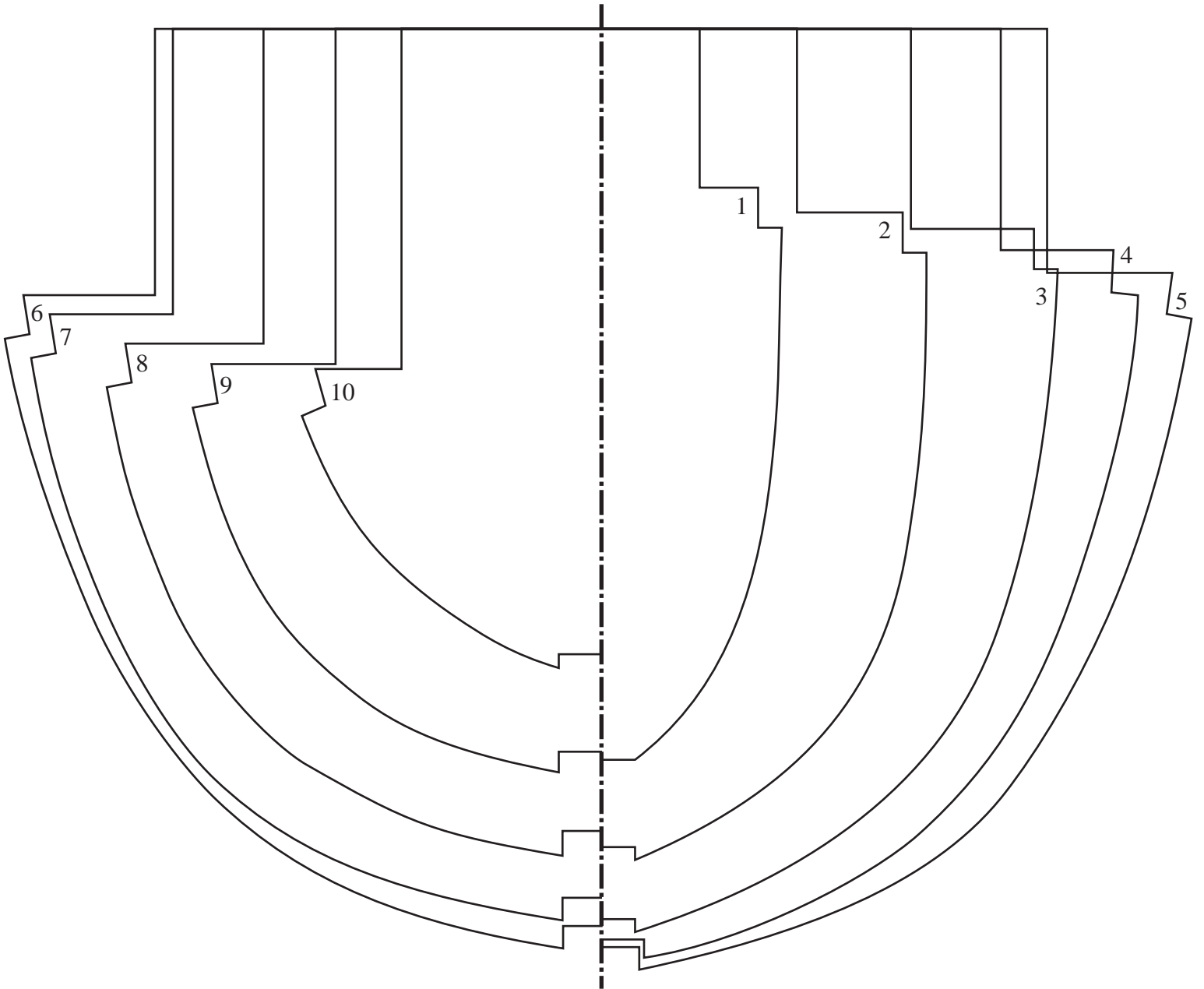

# ADVANCE MK 1

A Carl G. Schaefer, Jr. Design

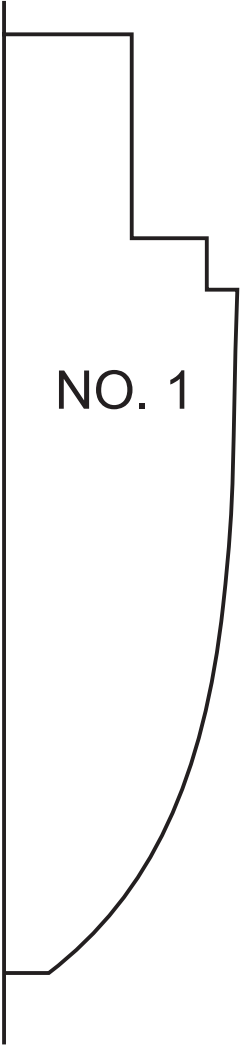

NO. 1

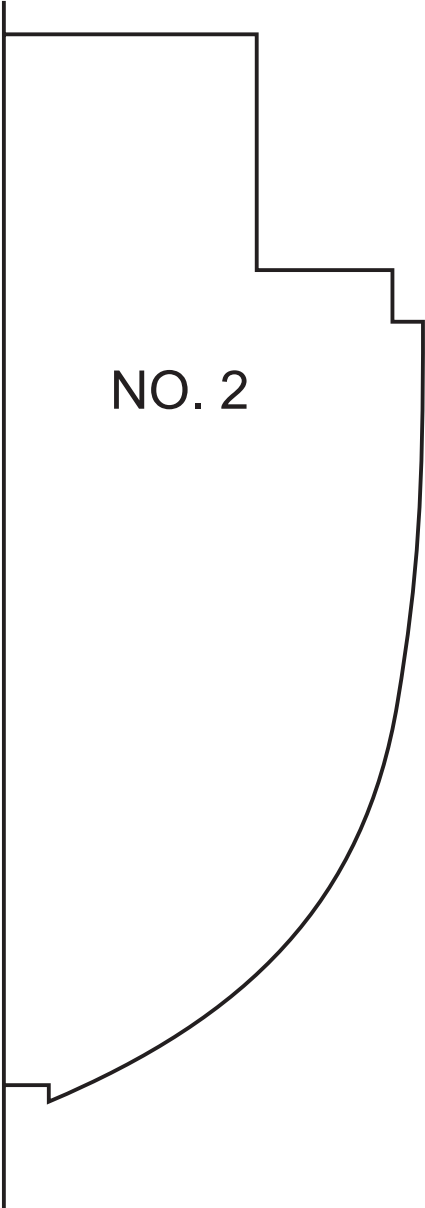

NO. 2

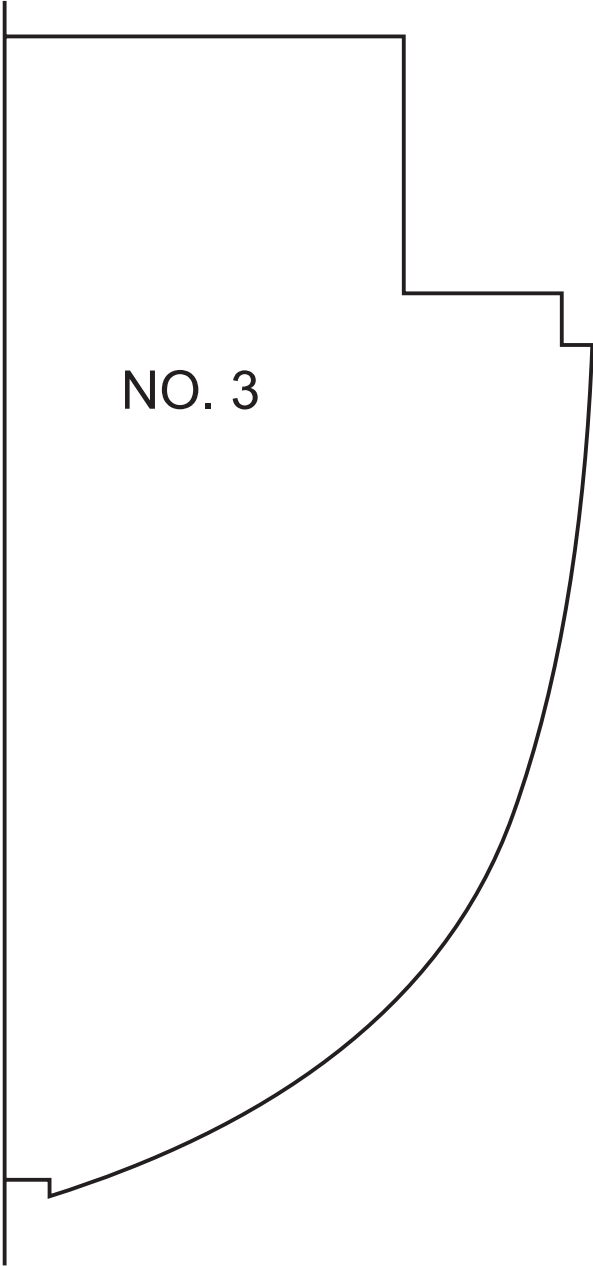

NO. 3

# ADVANCE MK I

A CARL G. SCHAEFER, JR. DESIGN

SHEET 1

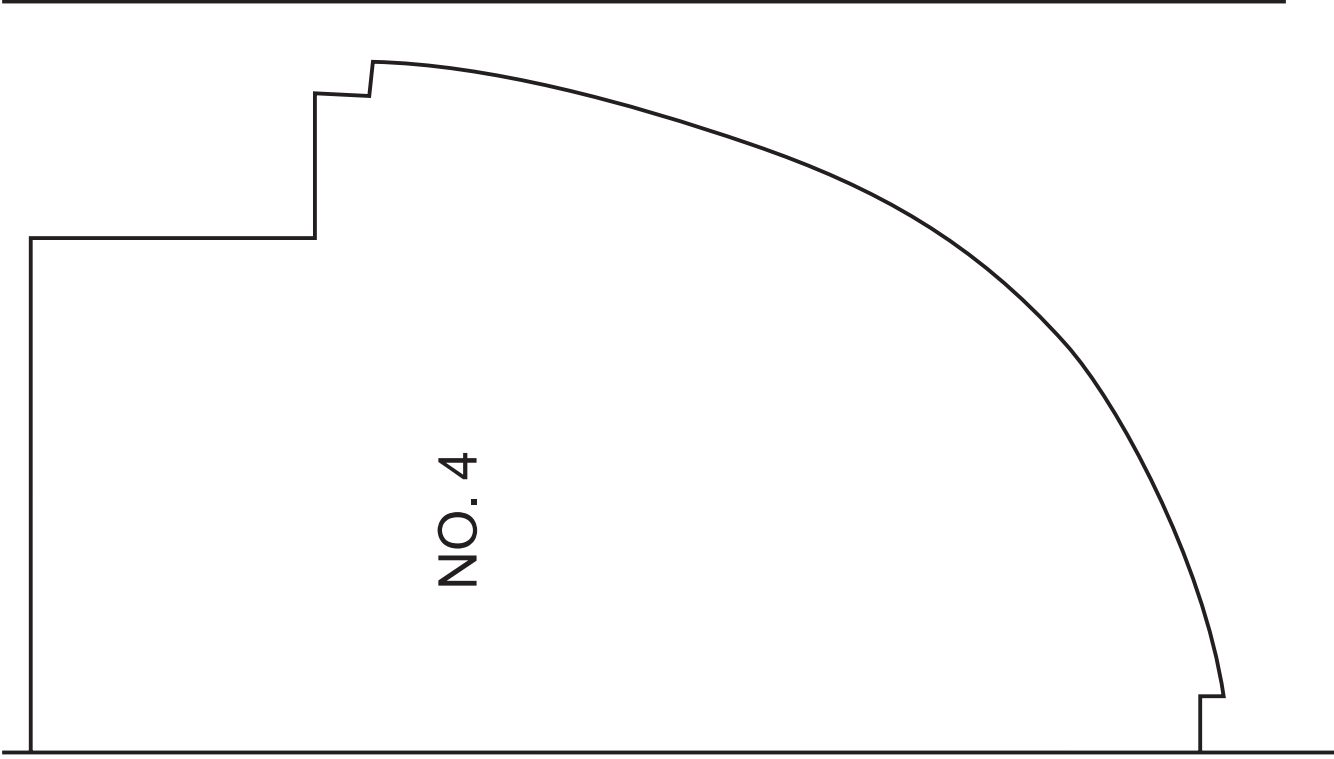

NO. 4

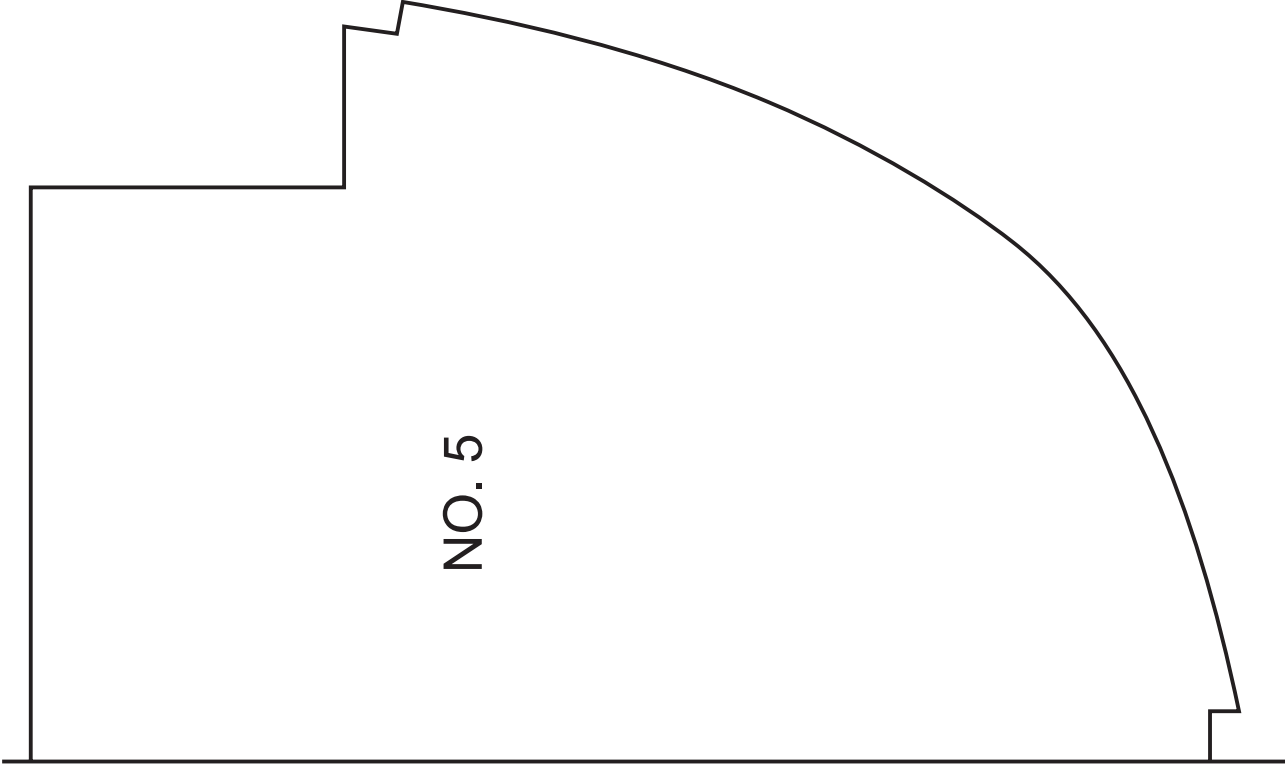

NO. 5

# ADVANCE MK I

A CARL G. SCHAEFER, JR. DESIGN

SHEET 2

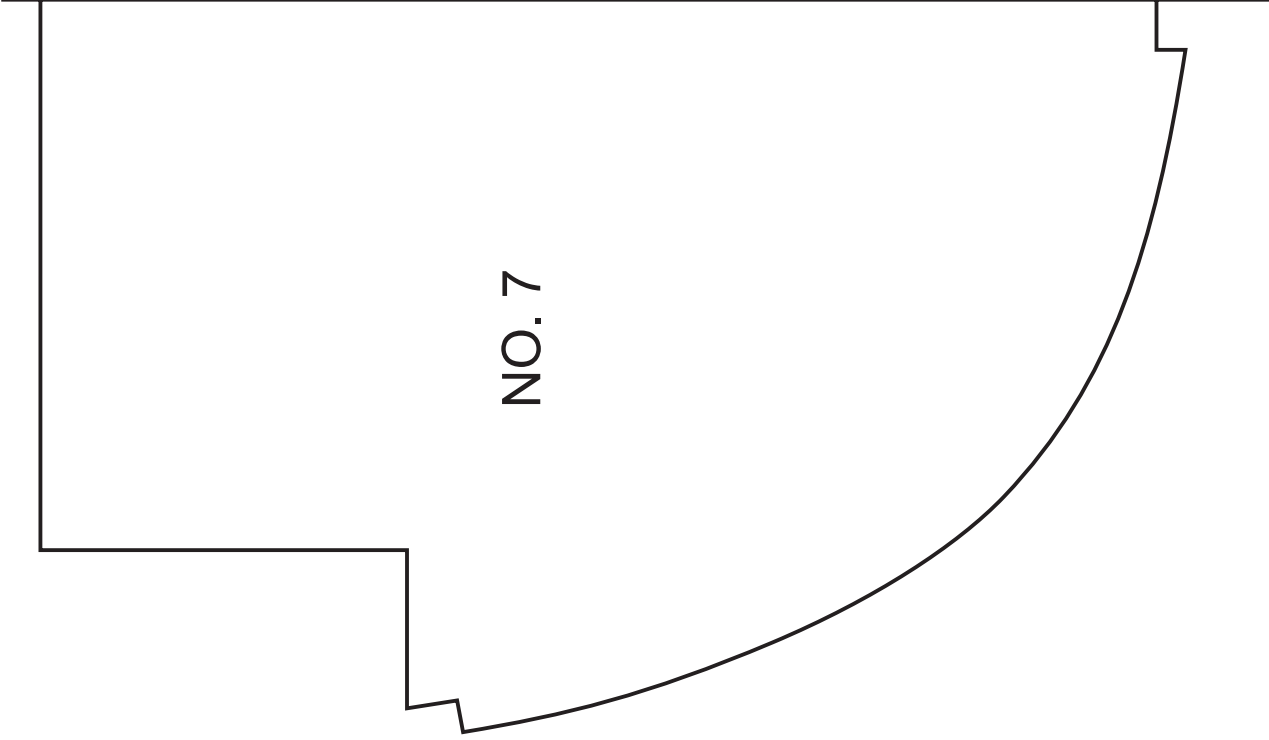

NO. 7

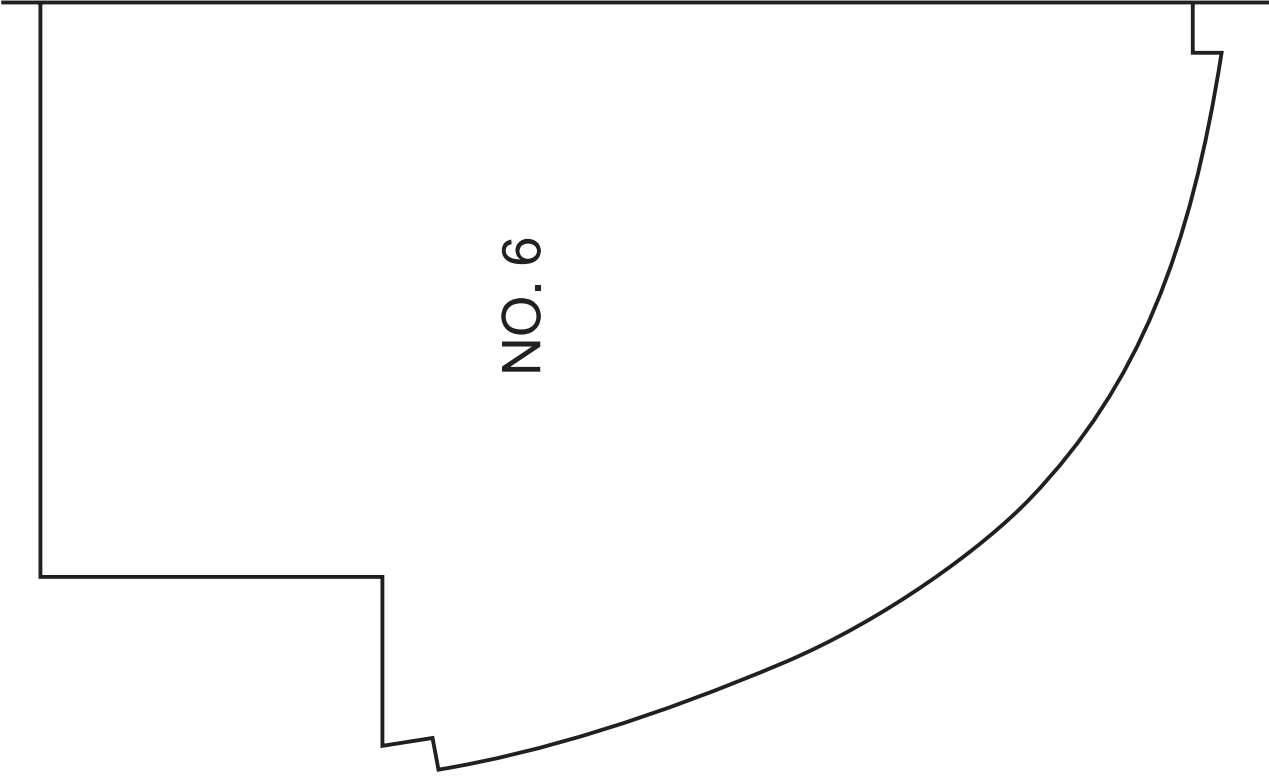

NO. 6

# ADVANCE MK I

A CARL G. SCHAEFER, JR. DESIGN

SHEET 3

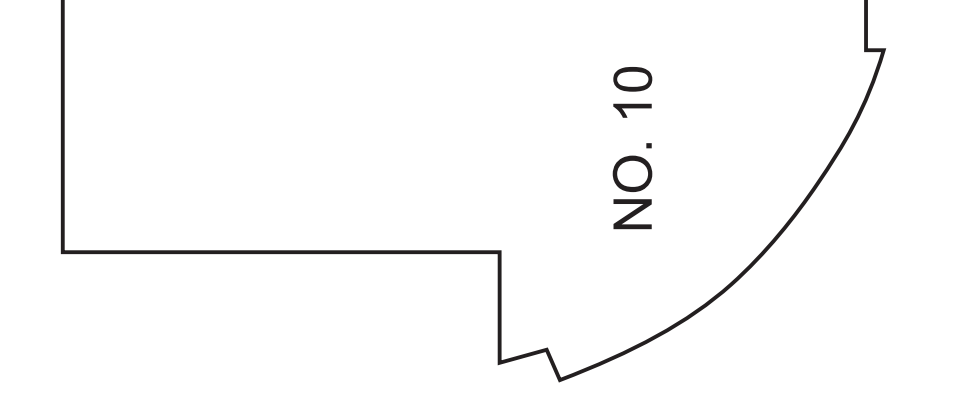
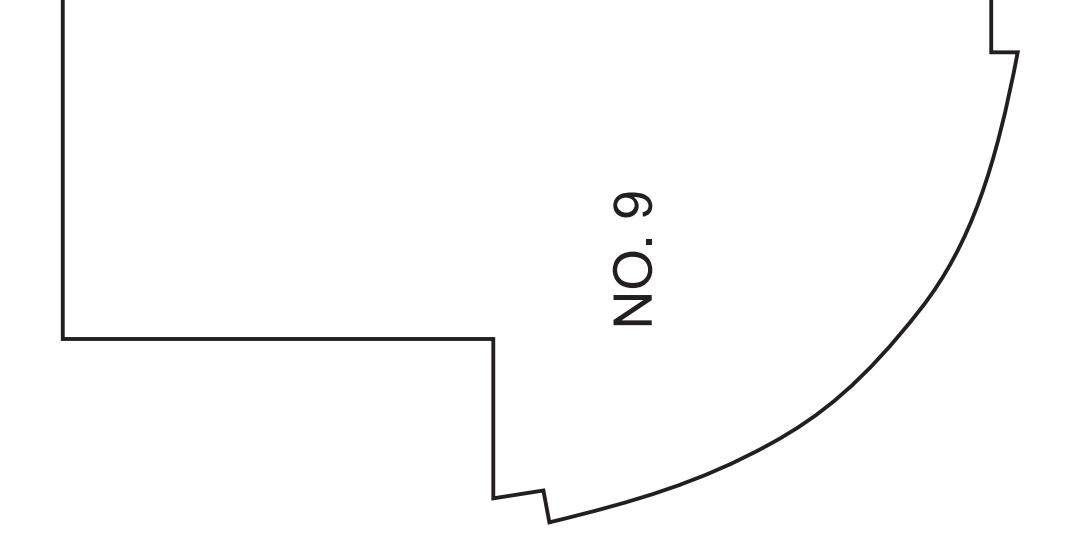
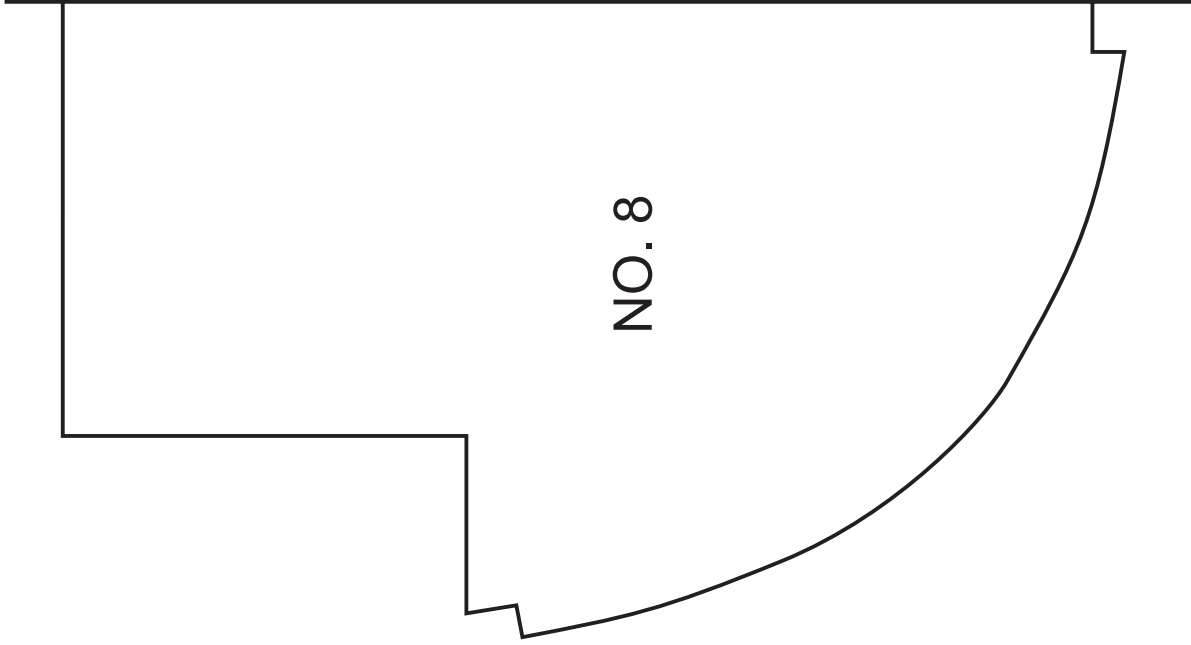

THIS BULB MAY HAVE TO  
BE SHAVED TO REDUCE  
WEIGHT. SUGGESTED WEIGHT  
4-5 LBS.

**NACA 16-018**  
APPROXIMATELY 5 LBS.  
POURED LEAD

STEM PIECE

RUDDER

# ADVANCE MK I

A CARL G. SCHAEFER, JR. DESIGN